

A Guide to Rules- for Model Bridge Building

by A.D.W. Sparks, B. Holdridge and A. Clothier.

Synopsis

This short paper provides a guide for school learners and to organisers of Model Bridge Building Competitions. Other verbal or written explanations will be provided at the venues of the Bridge Building Competitions. It is likely that these rules will be accepted as suitable for National Bridge Building Competitions.

Introduction

Model Bridge Building Competitions for school learners have become an integral part of the activities of the SA.Institution of Civil Engineering. The history and alternative forms of model testing will be described elsewhere. The views in this paper will be recorded in published form so that other organisers may use these rules. It is hoped that alterations or other views will also be published in a written form at future dates.

The Manner in which the competitions will be run

The steps in the bridge building competitions are as follows:--

- a.) The Local Branch of the SAICE will announce the date of the local competition, and will invite schools to submit their names for consideration. A local SAICE Branch committee might be forced to restrict the number of schools who partake. This is usually because of the limitation of the size of the venue, or because of the time limitation imposed by the testing procedures.
- b.) This set of rules will be issued to each school team accepted into the competition. This set of rules is a basic set of rules.
- c.) Construction kits will be issued to the teams on the morning of the competition.
- d.) The clear span distance for the bridges will be announced on the morning of the competition.
- e.) On the morning of the competition, the local organising committee might decide to provide a preliminary lecture on the interpretation of these rules, and on aspects of model bridge construction.
- f.) Each school team will construct a model bridge using the kits supplied. Guidance on the interpretation of the rules will be provided, on request, during this construction period. Teachers, parents and friends will not be allowed in the construction area during the construction of the model bridges.
- g.) The model bridge must be completed within a certain time.
- h.) A certain amount of time is required to allow the glue to harden, and for the judges to evaluate the bridges for aesthetic value.
- i.) At the time of testing, the members of each team will be required to load their own bridge model until it fails.
- j.) The score for each bridge will include a score for aesthetic value, plus a score for the maximum load which it carried.
- k.) The rulings of the appointed judges will be Final.
- l.) If the winning team is to be entered into a National Competition, then the details of the National Competition will be announced to the winning team.
- m.) All members of the organizing committee are voluntary workers who make decisions and arrangements in good faith. The SAICE and its office bearers are not responsible for any injuries, losses or inconveniences which might arise. Please see the Liability disclaimer at the end of the rules.

A Guide to Rules for Model Bridge Building (continued)

The Rules

The contents of the kit issued to teams on the day of the competition, are described in the Appendix to this paper. Substitute or additional material is not permitted.

Glue tubes are rationed:-

Glue will be provided for constructing the model bridges. The number of glue tubes will be limited. Usually each team will only be allowed two glue kits. Before the start of the construction, please check that you know the rules relating to the number of glue tubes, which are permitted for each team. Extra glue will not be allowed. If epoxy glue is issued, it requires to be thoroughly mixed (e.g. on a cardboard card prior to the application of the mixture to the wooden joints. Do not mix epoxy glue on the joints, as this will result in almost zero strength of the glue.

Imperfect wooden sticks:-

The wooden sticks will usually be cut from pine wood. Before the start of construction, check your sticks. If there are any imperfections such as knots, you will be allowed to exchange a stick prior to cutting the stick.

Bridge must be longer than the clear Span:-

Clear span of the bridge is the gap of the ravine over which the bridge will be built. This is also the clear gap on the testing bed. The total length of the final bridge should be at least 60 mm longer than the clear span. A team will not be disqualified if the length of bridge is more than 60 mm longer than the clear span, but it must be understood that the total mass of the bridge will increase.

The clear span, which is specified on the morning of the competition, is usually longer than the longest stick that is provided. Rules exist with regard to the method of joining or overlapping two sticks. See the section on "overlapping". Severe penalty points apply to a model bridge if its length is equal to, or shorter than, the clear span.

A cardboard piece for the deck of the bridge:-

A cardboard piece may be provided to form the deck of the bridge. i.e. the road surface. It may be glued on top of crosspieces, which join the two sides of the bridge. This deck must run the whole length of the bridge.

See Figure 1 and Figure 5c.

Clear Passageway required for traffic:-

A clear passageway must exist along the whole length of the bridge. This passageway must be 100 mm wide (i.e. inside dimension of bridge) and of height at least 100 mm above the cardboard deck.

Loading apparatus must fit the bridge:-

Teams are advised to study the loading apparatus.

During testing the weights will hang under the centre of the bridge. Please ensure that the loading device can be threaded through the side of the bridge, See Figure 2. The loading device may be borrowed from the organisers during construction of the bridge, so that a team may check that the loading device will fit between the members of the bridge, at the level of the deck of the bridge.

The loading device will either sit on the cardboard deck, or it can be supported in the region of the deck on the top of the side beams of the bridge (e.g. if these side beams are slightly higher than the deck). *See Figure 5c.*

A Guide to Rules for Model Bridge Building (continued)

The Rules (continued):

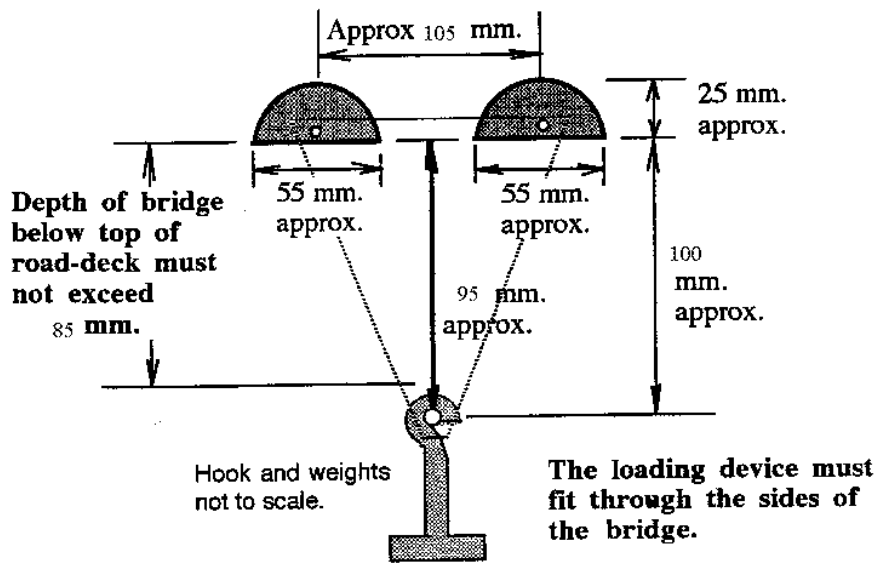
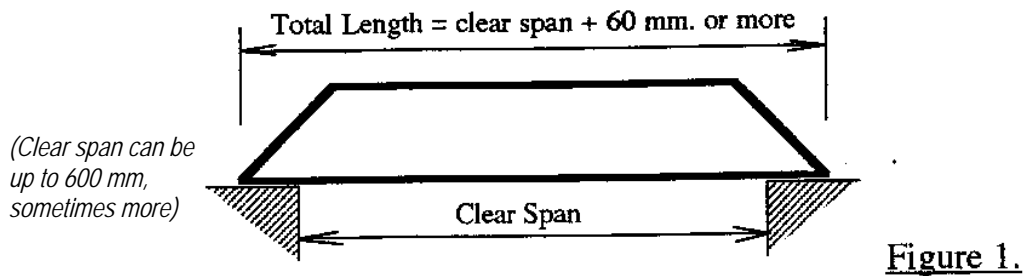
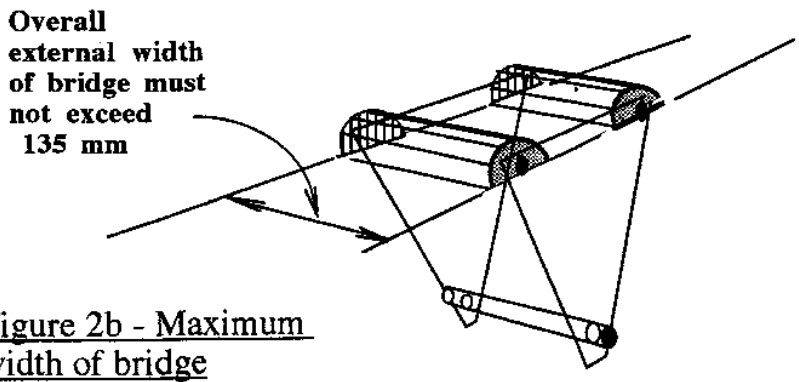

Figure 2a - Approximate Dimensions of a Loading Device :-
Please check the dimensions of the device at your venue.



A Guide to Rules for Model Bridge Building (continued)

Limit to bridge depth below the level of the roadway deck:-

The loading device has a horizontal rod about 100 mm below the level of the deck. The long hook carrying the loads hangs from this horizontal rod. The bridge depth, measured downwards from the level of the roadway, may not exceed 85 mm. at the centre of the bridge. (There is no limit to the height of the bridge above the level of the roadway, provided the free carriageway of 100mm by 100mm is preserved)

Teams may not bring predrawn bridge outlines:-

Teams may NOT bring predrawn bridge outlines or premade bridge models into the competition area. Teams may NOT bring their own boards for the purpose of using their board as a jig for clamping members during the glueing process. Teachers, parents and friends may not give advice during the building process. In this connection, cell phones may only be used by a team, while the user is standing with the convenor.

Suggested method of construction:-

Start early, by first constructing the most important members of the bridge, as the glue may be slow to dry. Read the section on "overlapping members"...

Each team will be provided with one large soft board plus approximately 30 long household sewing pins. Backing paper will be placed on the soft board so that glued joints do not stick to the soft board. It is suggested that a team should draw out the side views of the bridge on this backing paper. (Make sure that the bridge is longer than the clear span).

Teams may bring pocket calculators, and drawing instruments such as rulers, protractors and pencils into the competition area. Teams may also bring a small homemade wooden cutting block on which members may be held in place against a stop, while a cutting knife is used. Teams are encouraged to bring cutting tools such as an X-Acto type knife or a Stanley cutting knife, in order to make smoother cuts in members at the joints.

It is then an easy matter to cut the wooden members to fit on the drawing. Construct each side of the bridge as a flat grid on this backing paper, and use the household pins alongside the members in order to hold the joints in place, while the glue dries. When the sides of the bridge have been completed, the cross members between the two sides can be glued in place. Remember that the deck must fit on the bridge. Extra strength can be gained by glueing the cardboard deck to its supporting members. All four support comers of the bridge must be in the same plane.

Several methods for clamping Joints:-

- a.) The easiest method is the use of the soft board and pins described above.
- b.) Clothes pegs are also provided for clamping joints.
- c.) A thin piece of string (usually coloured) will also be provided which may be used on a temporary basis to hold together joints or portions of the bridge. This string must be removed prior to testing, and may not form part of the final structure.
- d.) In the past we have allowed teams to bring special clamps to hold together two or more members at a glued joint. These will continue to be allowed on an experimental basis. It is believed that methods (a), (b) and (c) are very efficient, and little advantage is gained if teams bring extra joint clamps.

A Guide to Rules for Model Bridge Building (continued)

If the glue requires as long period in order to set, then the model can be clamped in place as shown in Figure 3. If the glue is quickdrying, then it is still necessary to clamp certain members to be in the same plane. The four corner supports of the model bridge must be in the same plane.

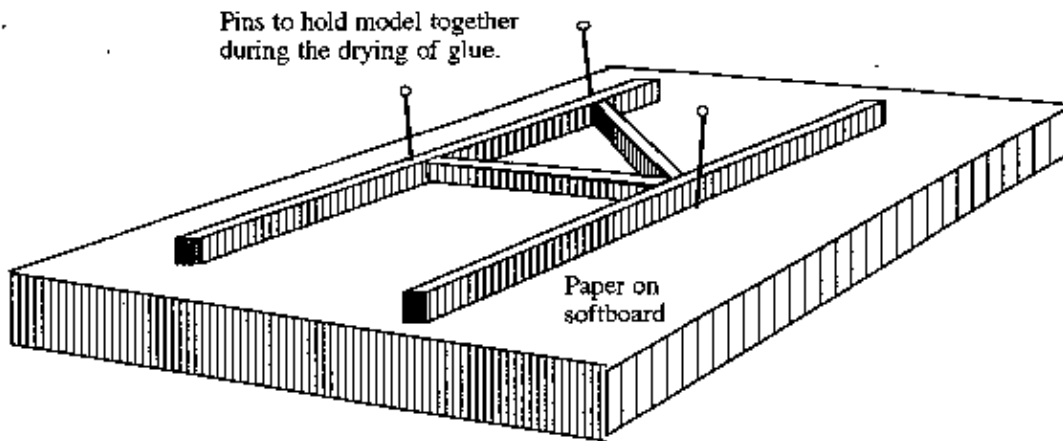

Figure 3 - Using pins and a soft board

Overlapping and joining of members:-

The general rule in this section:- "Two pieces which are running in the same direction (and this includes spacers) may not be glued together for a distance longer than 10 mm at any one spot. It is also no permitted to lay two pieces directly alongside each other (face to face) and merely glue them at points along their length. In this latter case spacers must be used."

a.) Two parallel members may not be glued together along their length. They may however be joined together via intermittent spacers as in Figure 4a. In figure 4a each spacer may not be longer that 10 mm, and the spacing between the spacers should be less than 50 mm

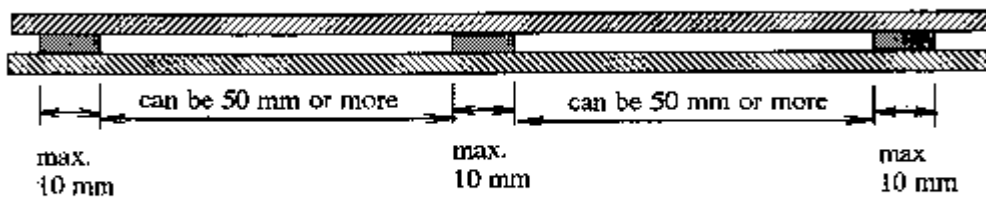

Figure 4a - Spacers

Overlapping and joining of members (continued):-

b.) Joining two members in a butt joint (Figure 4b), leads to a weak joint, especially if this is used in a tension member.



Figure 4b - Butt Joint - a weak joint

c.) A butt joint can be strengthened by using side pieces. (Figure 4c)

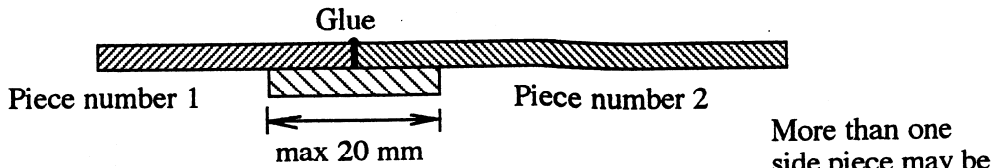

Figure 4c - Butt Joint - with side pieces.

d.) A spliced joint is a stronger joint than a butt joint (See Figure 4d). Side pieces (20 mm long) may also be used on the sides of this joint.

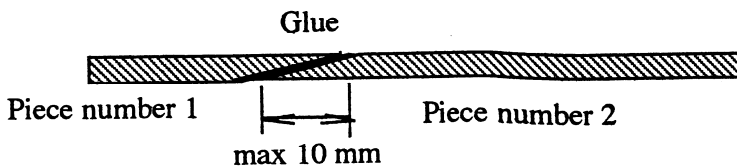

Figure 4d - Spliced Joint - a stronger joint than a butt joint.

e.) A simple lap joint of two members :-

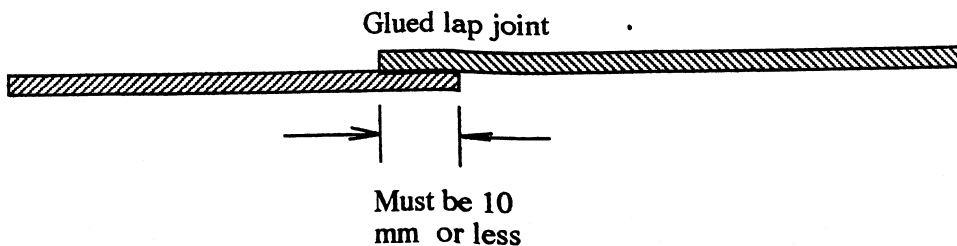

Figure 4e - Permissible Lap joint

Building up compression members:-

It is known that compression members first buckle sideways when loaded. Thereafter they deform too far in the sideways direction, at which stage they break. A single stick of wood can more easily carry a tension force than a compressive force. Members which carry large compressive forces must be strengthened. The members along the upper outline of the bridge (top chord) are usually the compressive members.

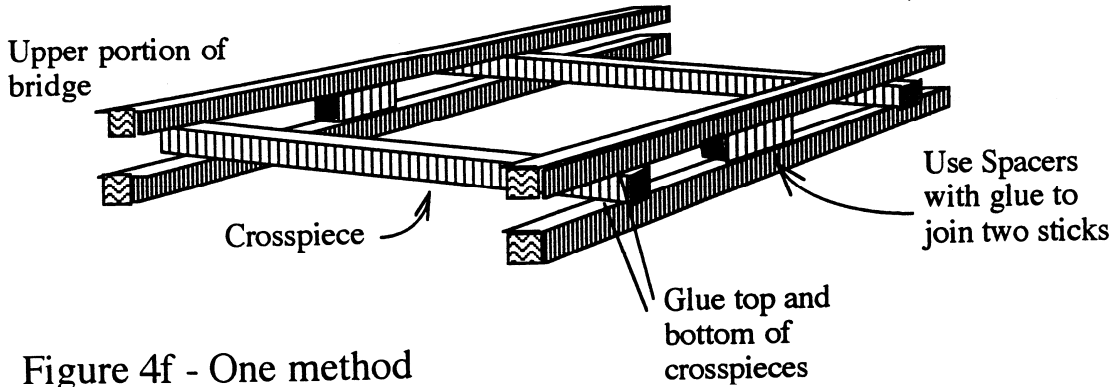

Figure 4f - One method

Compression members can also be built up from more sticks.

Upper portion of bridge

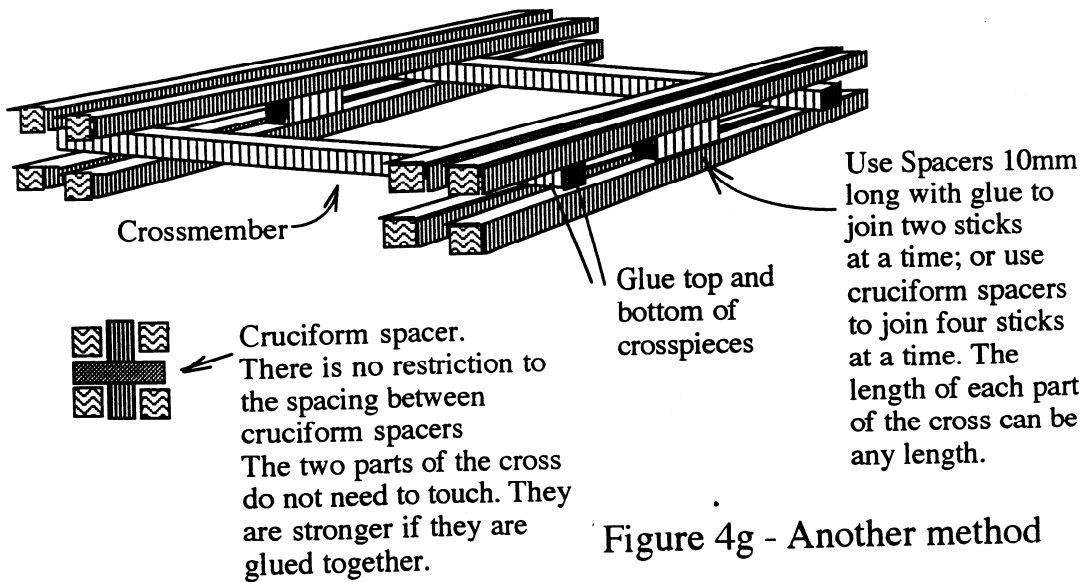

Figure 4g - Another method

The vertical portion of any cruciform spacer can be one of the vertical members or one of the diagonal members of the bridge, and the horizontal portion of any cruciform spacer can be one of the horizontal members of the bridge. Diagonal members in the horizontal plane, can also be used as one of the horizontal portions of a "cruciform" type spacer.

Using three sticks :-

The three sticks in Figure 5a are too close together. As a unit they do not provide much compressive strength. They should be further apart.

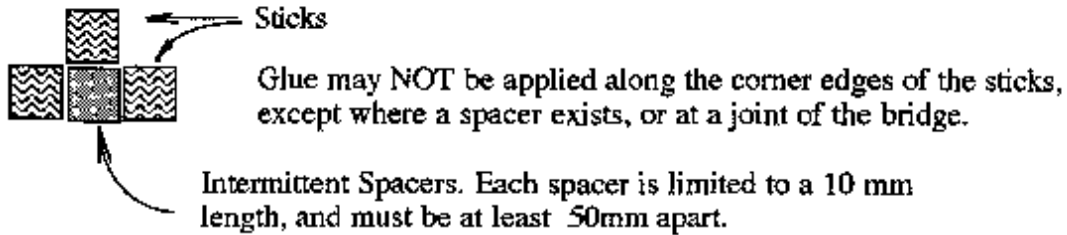

Figure 5 a - You may use three sticks.

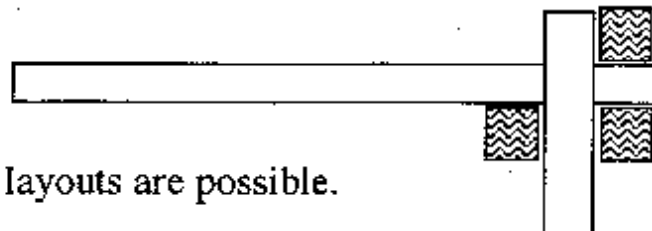

Figure 5 b - Other layouts are possible.

Other layouts for three or more sticks may be used. For the different sticks to act in unison, they should be joined by spacers along their lengths at intervals.

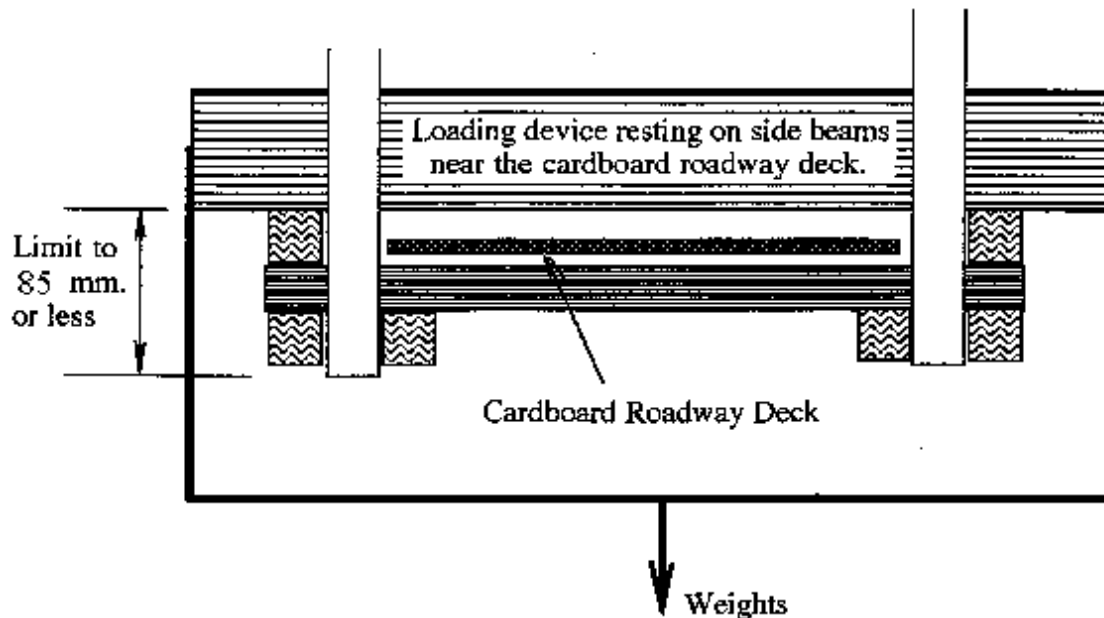

Figure 5 c - Section at Deck Level - Note that the Loading Device can rest on the side beam instead of on the cardboard deck.

Note, the limit of 85 mm to underside of bridge. See above figure.

A Guide to Rules for Model Bridge Building (continued)

No restrictions on glued length at bridge joints:-

The position where members come together from different directions is known as the bridge joint. There is no restriction on overlapping glue distances at a bridge joint. Members can also come together at a bridge joint from any direction.

An extra length of strong- string:-

You will be provided with a 3m length of strong string which you may use in any manner as part of the final structure. It may be cut and knotted, or stuck to portions of the bridge. If a team decides to unravel the string and to use its separate pieces, the team is required to warn the organisers that this unravelled string is not part of the thin string used for temporary construction (the latter is discarded prior to testing).

Bracing of bridge against supports:-

Up to the present, we have prevented teams from designing bracing against the abutments which support the bridge. But if suitable testing frames exist, then it may be announced by the organisers that bridges which brace against abutment supports will be permitted. The testing frame will be available for measurements. Teams should anticipate that such an announcement may be made on the morning of the competition. Teams should have thought about two different types of design prior to the competition. If permitted, bracing will not be compulsory.

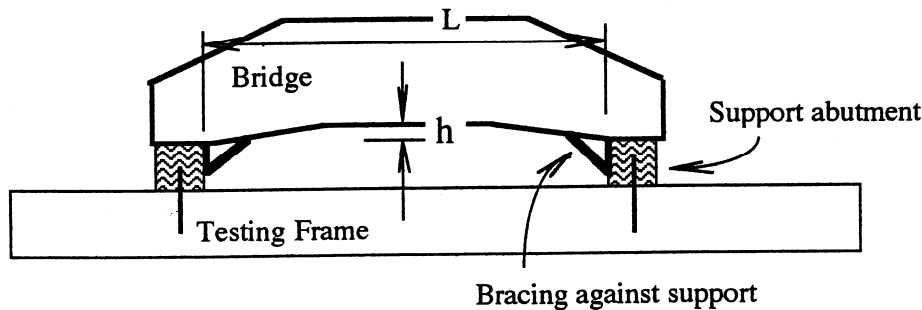

Figure 6 - Support Bracing - if permitted by organisers.

Roadways which are not level:-

Some teams wish to use a slightly humped roadway, even in conventional bridges which are not braced against their supports. The maximum hump distance permitted is $h L / 6$ where L = the clear span.

Aesthetic Value:-

The judges will first give an aesthetic value to the bridge (e.g. out of 30 points).

The aesthetic value will depend mainly on the form or shape of the bridge . The simplicity of design is important. The members of a structure should be those that are obviously necessary for its stability. Extra frills usually detract from the simplicity of the structure. Does the bridge look as though it is a bridge designed to carry loads.

A bridge that looks like a roof truss (i.e. high centre point diminishing to zero height near supports) may be able to carry a high load, but it might receive a lower aesthetic score than a model which looks like a bridge which will carry a moving vehicle. Neatness of workmanship will also be a factor.

A Guide to Rules for Model Bridge Building (continued)

Testing Procedures:-

The mass of each bridge will be measured prior to the load testing. The order of testing will be decided by the judges. Bridges will be centrally loaded until they fail. Usually this will be done by using dead weights which are applied by the members of the respective team. The starting load may be stipulated to be 50 percent of the previous highest load achieved by other bridges previously tested on this day. Team members should not look upwards while placing weights on hangers under bridges, and in particular they are asked to ensure that falling portions of the bridge or portions of the loading device do not injure their eyes. Judges will decide whether a load has been carried for long enough (e.g. five seconds).

Decision of the judges:-

The decisions of the judges will be final. The winning bridge may, after testing, be retained by the judges and may be subjected to further examination.

Disqualification:-

Each model bridge will be inspected, and any violation of the above rules can cause immediate disqualification, or a penalty score. The judges might allow a bridge to be corrected to comply with the rules.

Liability:-

The South African Institution of Civil Engineering (SAICE) and other sponsoring organizations, and the members of the SAICE do not accept liability for injury or inconvenience to members of teams, or to members of the public during the competition, during the loading of the bridges and during travelling to and from a competition. Such risk is carried entirely by the team and its members.

Suggested formula for judging bridges:-

The following formulae have been found to be acceptable. Either of these two formula may be used:-

$\text{Score} = \text{Aesthetics out of 30} \\ + 200 \times \left\{ \frac{\text{Failure Load kg}}{\text{Mass of Bridge . grams}} \right\}$
$\text{Score} = \text{Aesthetics out of 30} \\ + 20 \times \left\{ \frac{\text{Failure Load Newtons}}{\text{Mass of Bridge grams}} \right\}$

Figure 7 - Suggested Formula for scoring

A Guide to Rules for Model Bridge Building (continued)

Items which teams may bring to the competition:-

Pocket calculator for trigonometric calculations.

Drawing instruments. e.g. Pencils, Protractor, Tape, Rulers, set squares.

Cutting tools such as X-Acto or Stanley knife, and sandpaper.

A block of wood for cutting, e.g. with a small stop.

Small weights to place on joints while the glue dries. (e.g. these can be small sealed bags filled with sand).

Small clamps for holding sticks together at a Joint. (these will probably not be necessary as other clamping systems are provided).

Items which teams may NOT bring into the competition:-

Under no circumstances may any team bring and use an item that will give them an unfair advantage over another team.

These items include any 'power' operated items such as fans, hair dryers, electrical cutting equipment, etc

Teams may not bring models of bridges, or predrawn sketches of bridges into the competition.

Boards devised by teams as jigs for laying out bridge systems are not permitted.

Teachers, parents and friends may not communicate design decisions to team members while the model bridges are being built.

Items within the kit from the SAICE organisers:-

25 wooden sticks (approximately 4mm. x 4mm x 600 mm)

One set of Epoxy Glue. Extra glue will not be permitted.

One large soft board (optional) plus approximately 30 household pins.

Backing paper for the softboard (optional). Teams may draw on this paper.

Three metre length of strong cotton string which can be used in the final model.

Some thin or coloured string for temporary clamping this is not part of the final model.

Wooden clothes pegs for temporarily "clamping" construction joints.

A mini-saw.

Elastoplast or Bandaid for cuts will be available at the organiser's table.